

Window Treatment Elevation + Section View

Specification # (A) GR-400

Scale: NTS



Standard Guestroom Window Treatments
New Build - Vibrant Scheme



PRODUCT DISCLAIMER: Fabtex is a manufacturer of commercial products that require installation by a licensed contractor. All information shown is for schematic purposes and to aid coordination amongst trades. All wiring, connections, means and methods is to be performed by others in strict adherence with all federal, state and local building codes.

CONFIDENTIAL: All materials disclosed in this document are proprietary to Fabtex, Inc. The holder agrees to maintain it in confidence and must not replicate or reveal this information in any manner.

Fabric to meet NFPA 701 FR Standards. Roller Shade Lift System to comply with ANSI WCMA A100.1, Section 2515.03 safety standards.



Date: July 16, 2024

Ribbed Bracket Mounting

Scale: NTS

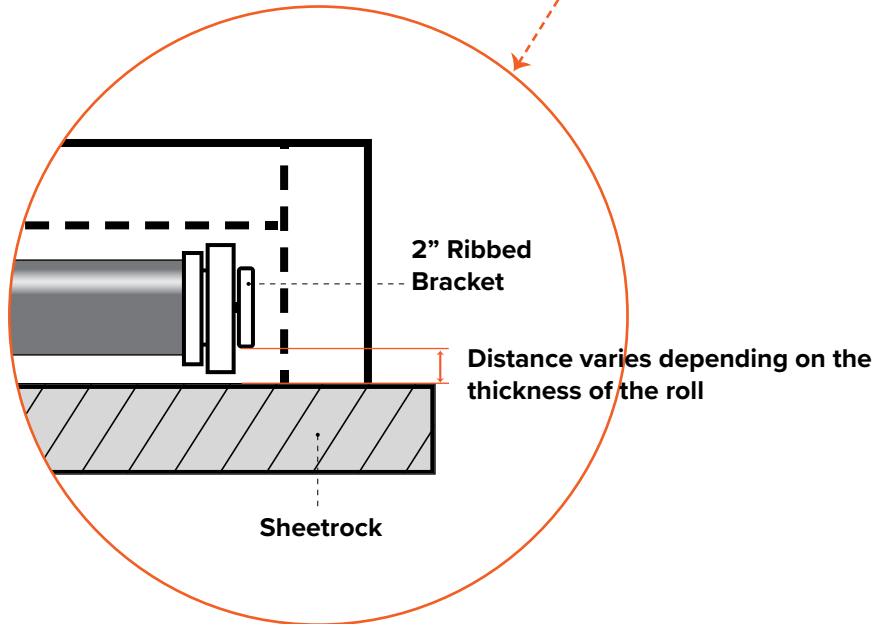
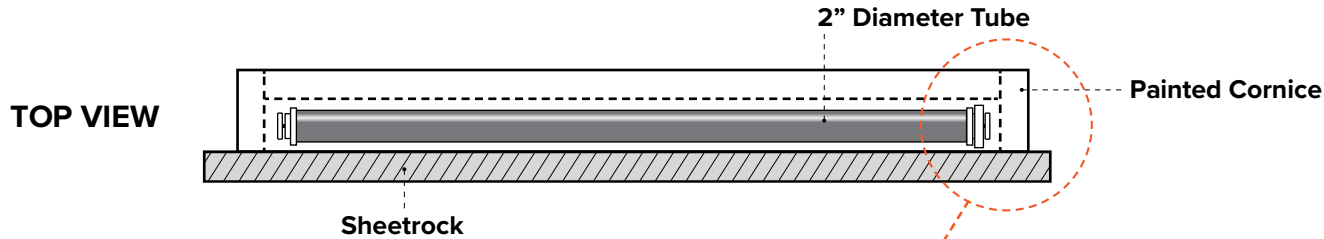
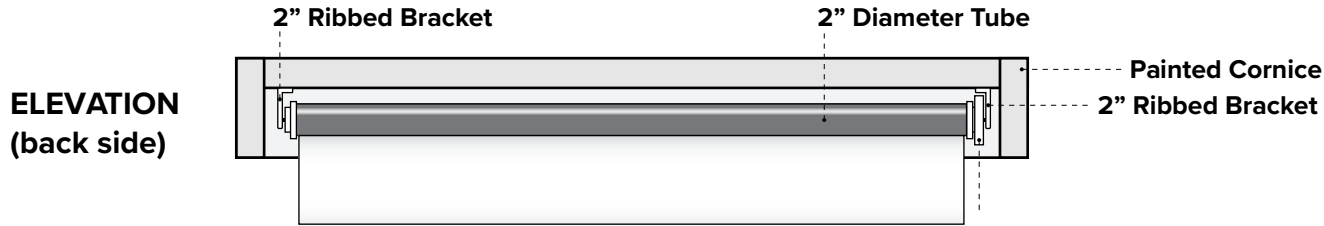

Hilton

HOME 2
SUITES BY HILTON

Standard Guestroom Window Treatments Installation Details

(A)/(B) GR-400, GR-401
(B) GR-450, GR-451

PRODUCT DISCLAIMER: Fabtex is a manufacturer of commercial products that require installation by a licensed contractor. All information shown is for schematic purposes and to aid coordination amongst trades. All wiring, connections, means and methods is to be performed by others in strict adherence with all federal, state and local building codes.

CONFIDENTIAL: All materials disclosed in this document are proprietary to Fabtex, Inc. The holder agrees to maintain it in confidence and must not replicate or reveal this information in any manner.

F A B T E X

Date: July 16, 2024

Cornice Mounting

Scale: NTS

Foam is applied to the back edge of the painted cornice's dustcap and returns which helps compensate for variations in the sheetrock.

ELEVATION (back side)

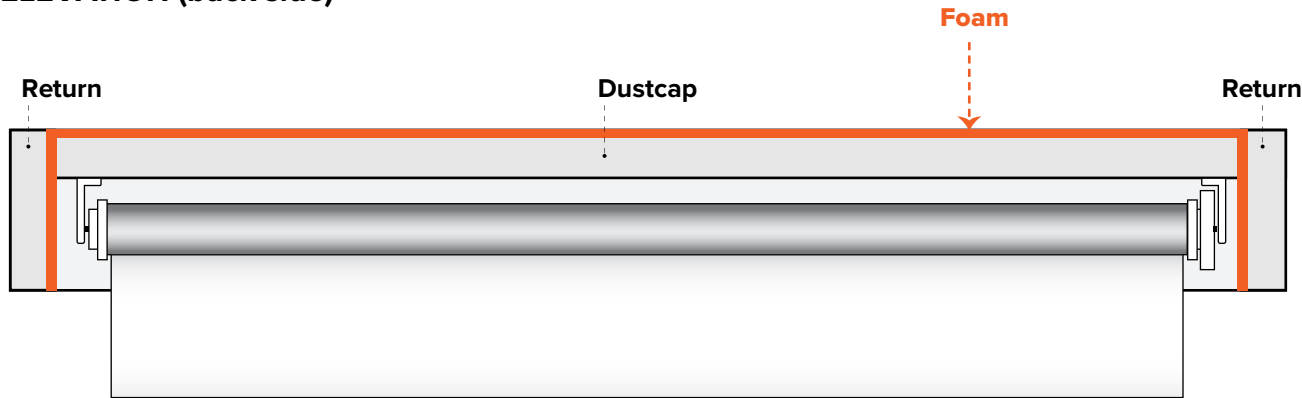

TOP VIEW

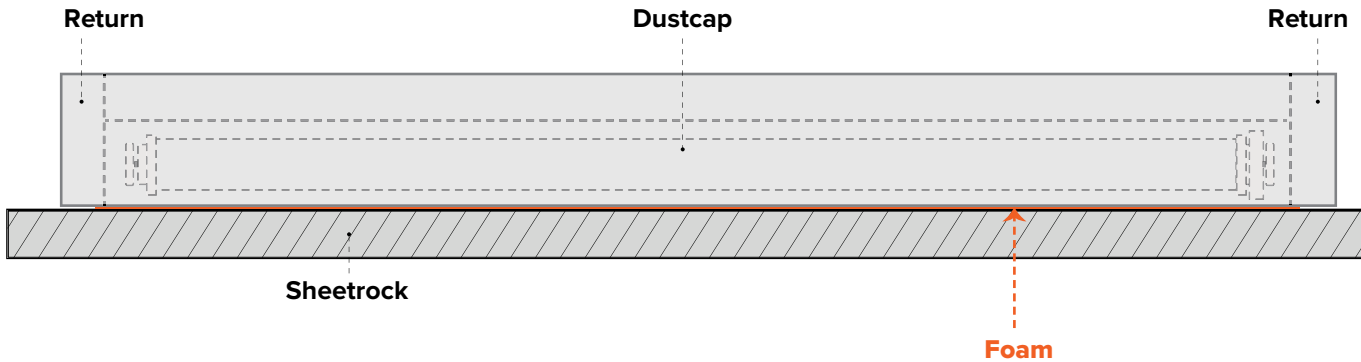

Standard Guestroom Window Treatments Installation Details

(A)/(B) GR-400, GR-401
(B) GR-450, GR-451

PRODUCT DISCLAIMER: Fabtex is a manufacturer of commercial products that require installation by a licensed contractor. All information shown is for schematic purposes and to aid coordination amongst trades. All wiring, connections, means and methods is to be performed by others in strict adherence with all federal, state and local building codes.

CONFIDENTIAL: All materials disclosed in this document are proprietary to Fabtex, Inc. The holder agrees to maintain it in confidence and must not replicate or reveal this information in any manner.



Date: July 16, 2024

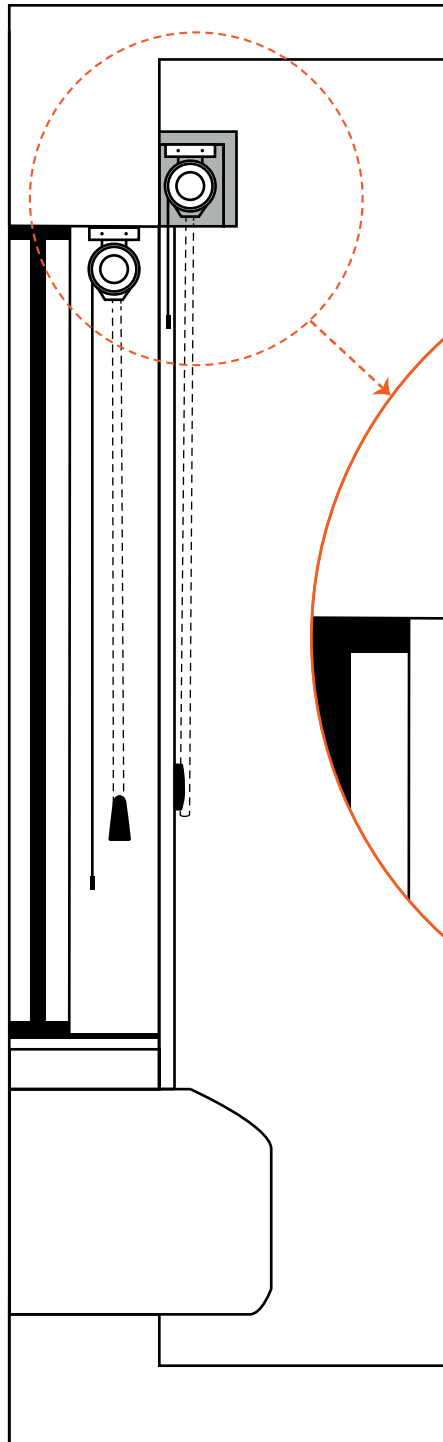

Cornice Mounting

Scale: NTS

Cornice is wall mounted via angle brackets

6"

Distance from top of cornice to window jamb

6"

Distance from window jamb to blackout shade's upper limit

3/8" max distance



Standard Guestroom Window Treatments Installation Details

(A)/(B) GR-400, GR-401
(B) GR-450, GR-451

PRODUCT DISCLAIMER: Fabtex is a manufacturer of commercial products that require installation by a licensed contractor. All information shown is for schematic purposes and to aid coordination amongst trades. All wiring, connections, means and methods is to be performed by others in strict adherence with all federal, state and local building codes.

CONFIDENTIAL: All materials disclosed in this document are proprietary to Fabtex, Inc. The holder agrees to maintain it in confidence and must not replicate or reveal this information in any manner.



Date: July 16, 2024

Sill Placement

Scale: NTS

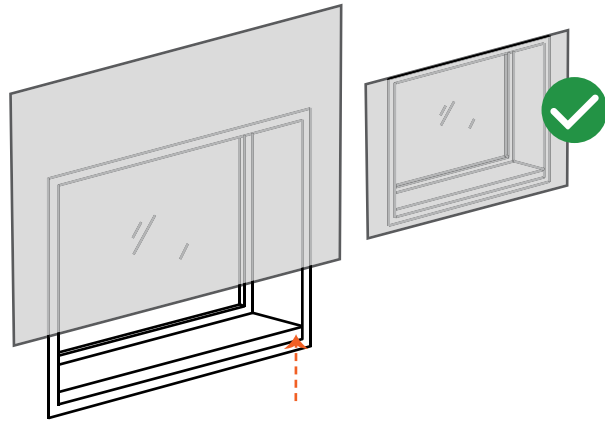

Sill must be flushed to the sheetrock so the blackout can close properly.

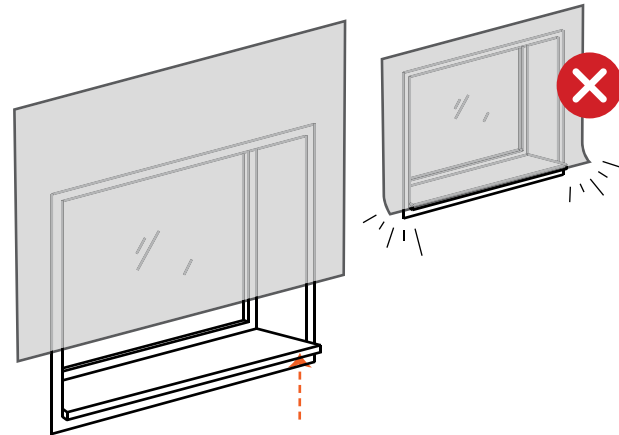

If not flushed, the sill will push the blackout away — letting light in.

Fabric Band Extension

Scale: NTS

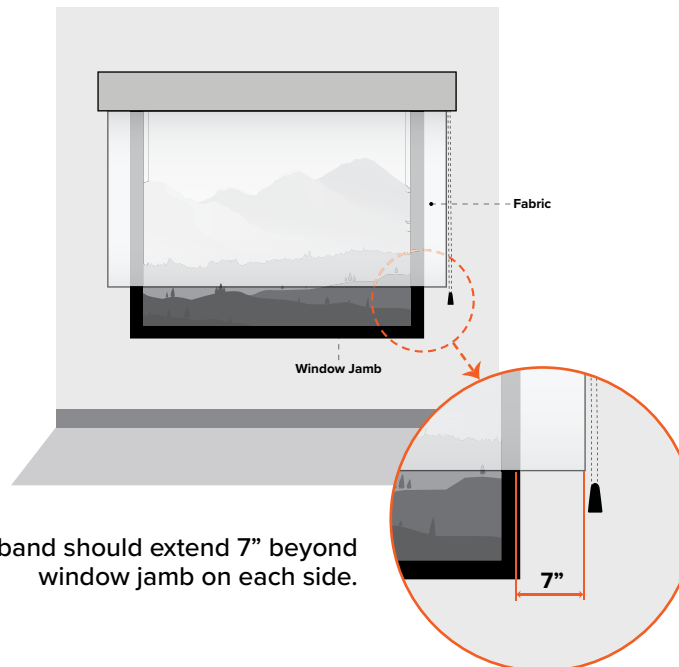

Fabric band should extend 7" beyond window jamb on each side.



Standard Guestroom Window Treatments Installation Details

(A)/(B) GR-400, GR-401
(B) GR-450, GR-451

PRODUCT DISCLAIMER: Fabtex is a manufacturer of commercial products that require installation by a licensed contractor. All information shown is for schematic purposes and to aid coordination amongst trades. All wiring, connections, means and methods is to be performed by others in strict adherence with all federal, state and local building codes.

CONFIDENTIAL: All materials disclosed in this document are proprietary to Fabtex, Inc. The holder agrees to maintain it in confidence and must not replicate or reveal this information in any manner.



Date: July 16, 2024

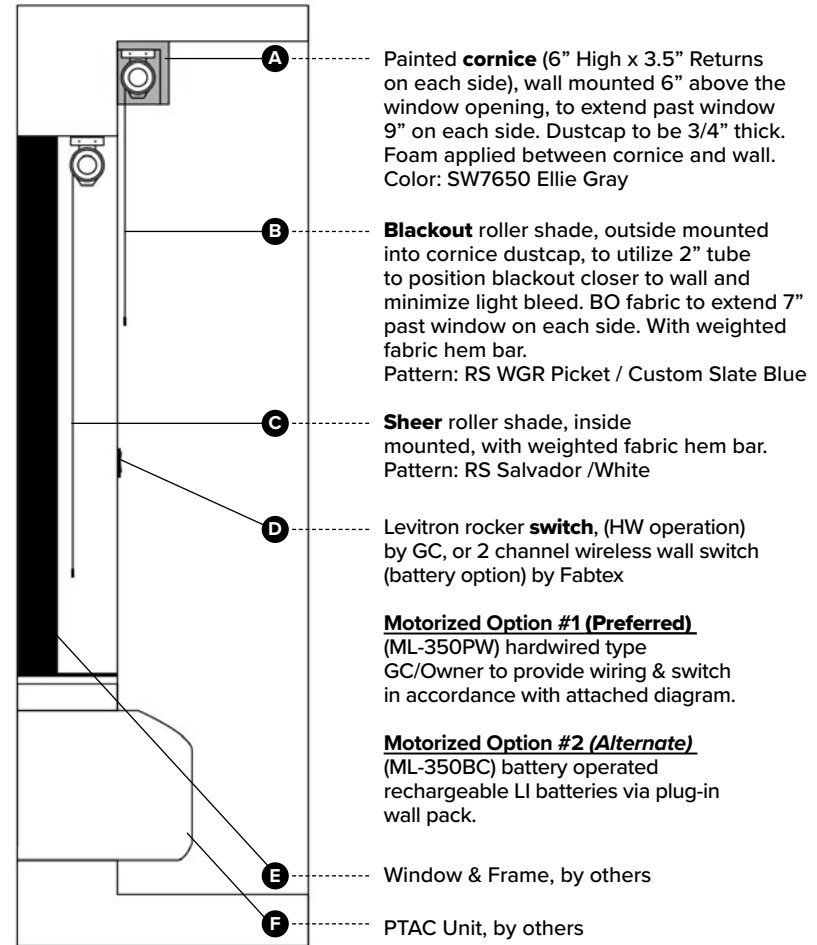

Window Treatment Elevation + Section View

Specification # (A) GR-401

Scale: NTS



ADA Guestroom Window Treatments
New Build - Vibrant Scheme



PRODUCT DISCLAIMER: Fabtex is a manufacturer of commercial products that require installation by a licensed contractor. All information shown is for schematic purposes and to aid coordination amongst trades. All wiring, connections, means and methods is to be performed by others in strict adherence with all federal, state and local building codes.

CONFIDENTIAL: All materials disclosed in this document are proprietary to Fabtex, Inc. The holder agrees to maintain it in confidence and must not replicate or reveal this information in any manner.

Fabric to meet NFPA 701 FR Standards. Roller Shade Lift System to comply with ANSI WCMA A100.1, Section 2515.03 safety standards.

Note: All work performed by GC/EC must be in strict accordance with all local building & accessibility codes.



Date: July 16, 2024

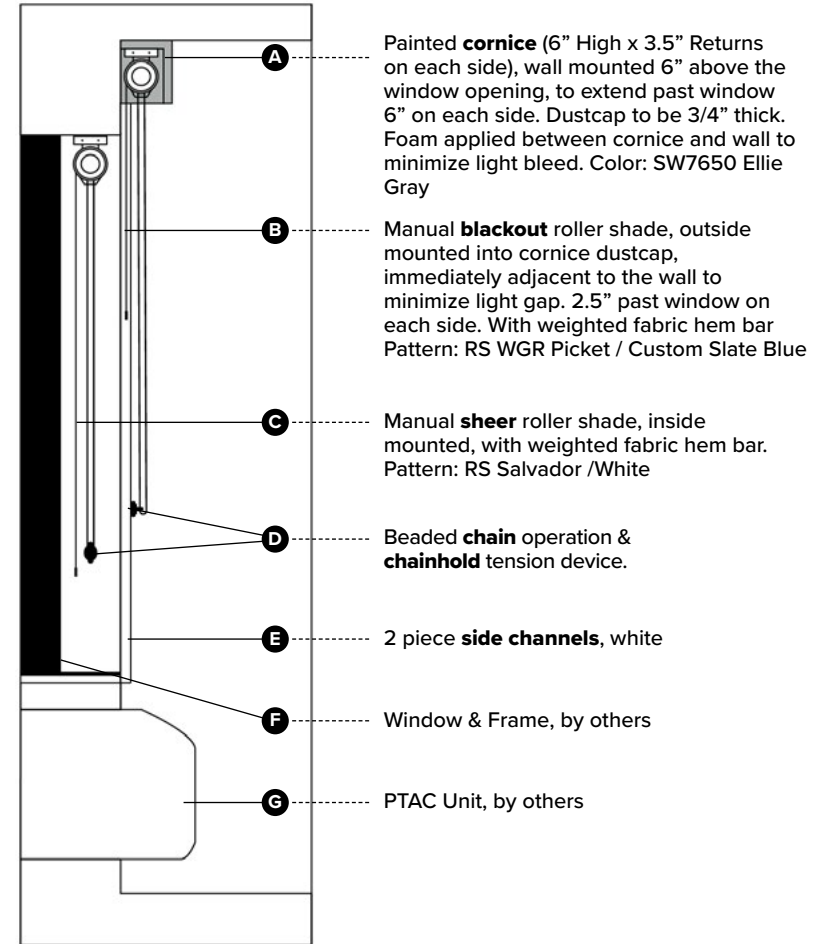

Window Treatment Elevation + Section View

Specification # (A) GR-452

Scale: NTS

Hilton

Guestroom Window Treatments
Renovation - Vibrant Scheme

HOME 2
SUITES BY HILTON

PRODUCT DISCLAIMER: Fabtex is a manufacturer of commercial products that require installation by a licensed contractor. All information shown is for schematic purposes and to aid coordination amongst trades. All wiring, connections, means and methods is to be performed by others in strict adherence with all federal, state and local building codes.

CONFIDENTIAL: All materials disclosed in this document are proprietary to Fabtex, Inc. The holder agrees to maintain it in confidence and must not replicate or reveal this information in any manner.

Fabric to meet NFPA 701 FR Standards. Roller Shade Lift System to comply with ANSI WCMA A100.1, Section 2515.03 safety standards.

F A B T E X

Date: July 16, 2024

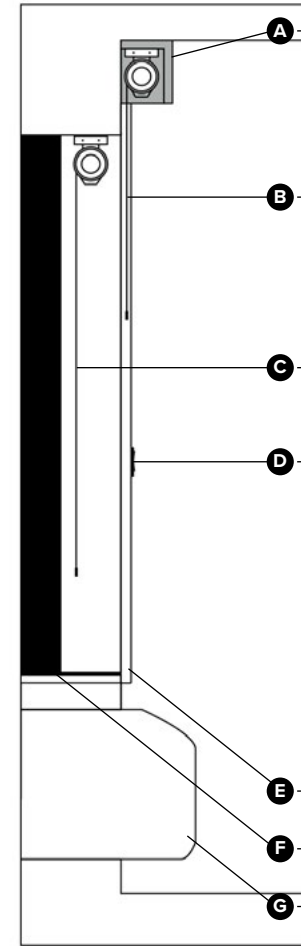

Painted **cornice** (6" High x 3.5" Returns on each side), wall mounted 6" above the window opening, to extend past window 6" on each side. Dustcap to be 3/4" thick. Foam applied between cornice and wall to minimize light bleed. Color: SW7650 Ellie Gray

Blackout roller shade, outside mounted into cornice dustcap, immediately adjacent to the wall to minimize light gap. 2.5" past window on each side. With weighted fabric hem bar Pattern: RS WGR Picket / Custom Slate Blue

Sheer roller shade, inside mounted, with weighted fabric hem bar. Pattern: RS Salvador /White

Levitron rocker **switch**, (HW operation) by GC, or 2 channel wireless wall switch (battery option) by Fabtex

Motorized Option #1 (Preferred) (ML-350PW) hardwired type GC/Owner to provide wiring & switch in accordance with attached diagram.

Motorized Option #2 (Alternate) (ML-350BC) battery operated rechargeable LI batteries via plug-in wall pack.

E----- 2 piece **side channels**, white

F----- Window & Frame, by others

G----- PTAC Unit, by others

Window Treatment Elevation + Section View

Specification # (A) GR-453

Scale: NTS

Hilton

ADA Guestroom Window Treatments
Renovation - Vibrant Scheme

HOME 2
SUITES BY HILTON

PRODUCT DISCLAIMER: Fabtex is a manufacturer of commercial products that require installation by a licensed contractor. All information shown is for schematic purposes and to aid coordination amongst trades. All wiring, connections, means and methods is to be performed by others in strict adherence with all federal, state and local building codes.

CONFIDENTIAL: All materials disclosed in this document are proprietary to Fabtex, Inc. The holder agrees to maintain it in confidence and must not replicate or reveal this information in any manner.

Fabric to meet NFPA 701 FR Standards. Roller Shade Lift System to comply with ANSI WCMA A100.1, Section 2515.03 safety standards.

Note: All work performed by GC/EC must be in strict accordance with all local building & accessibility codes.

F A B T E X

Date: July 16, 2024

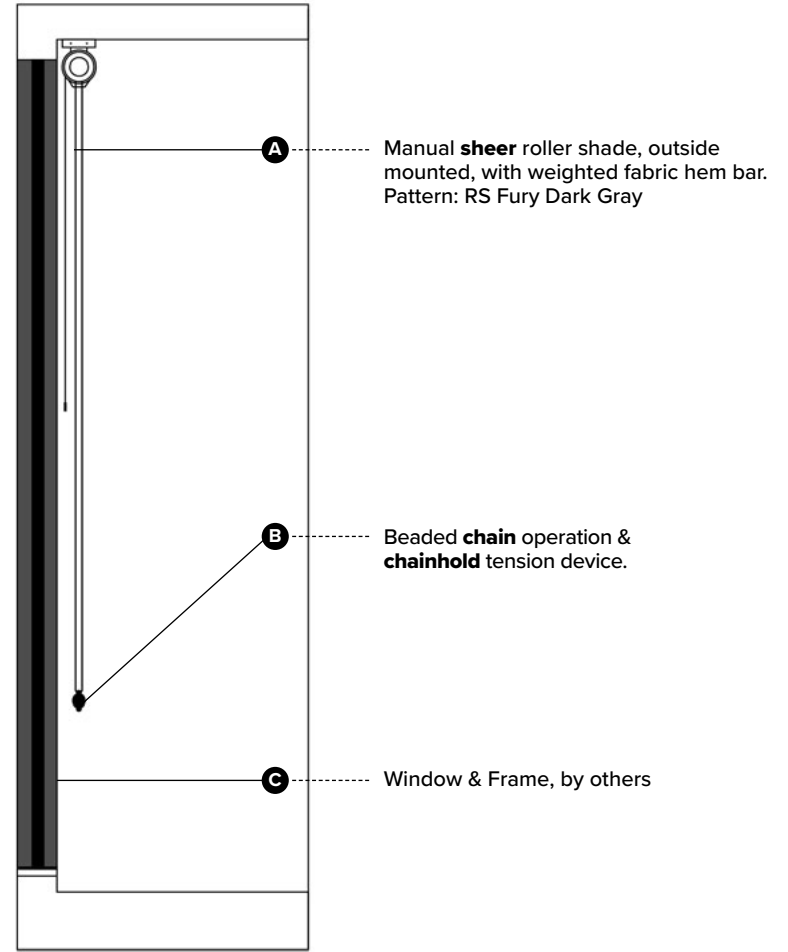

Window Treatment Elevation + Section View

Specification # PA-400

Scale: NTS

Hilton

Public Area Window Treatments
Vibrant Scheme

HOME 2
SUITES BY HILTON

PRODUCT DISCLAIMER: Fabtex is a manufacturer of commercial products that require installation by a licensed contractor. All information shown is for schematic purposes and to aid coordination amongst trades. All wiring, connections, means and methods is to be performed by others in strict adherence with all federal, state and local building codes.

CONFIDENTIAL: All materials disclosed in this document are proprietary to Fabtex, Inc. The holder agrees to maintain it in confidence and must not replicate or reveal this information in any manner.

Fabric to meet NFPA 701 FR Standards. Roller Shade Lift System to comply with ANSI WCMA A100.1, Section 2515.03 safety standards.

Spec #PA-400

- Lobby
- Fitness Room

F A B T E X

Date: July 16, 2024

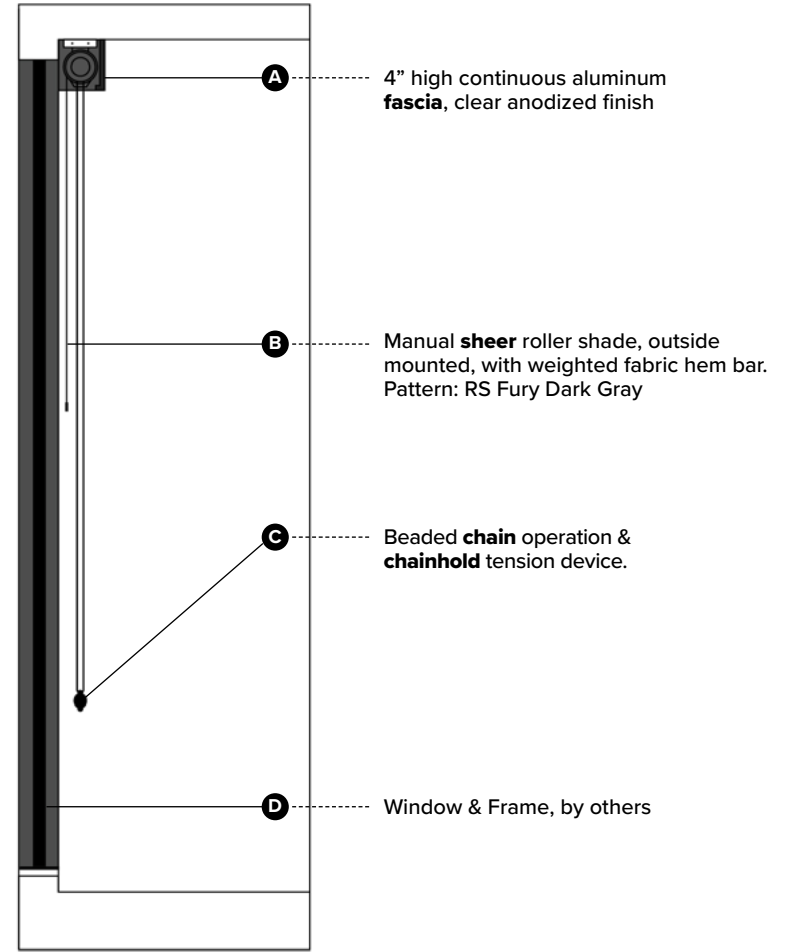

Window Treatment Elevation + Section View

Specification # PA-401

Scale: NTS



Public Area Window Treatments
Vibrant Scheme



PRODUCT DISCLAIMER: Fabtex is a manufacturer of commercial products that require installation by a licensed contractor. All information shown is for schematic purposes and to aid coordination amongst trades. All wiring, connections, means and methods is to be performed by others in strict adherence with all federal, state and local building codes.

CONFIDENTIAL: All materials disclosed in this document are proprietary to Fabtex, Inc. The holder agrees to maintain it in confidence and must not replicate or reveal this information in any manner.

Fabric to meet NFPA 701 FR Standards. Roller Shade Lift System to comply with ANSI WCMA A100.1, Section 2515.03 safety standards.

Spec #PA-401

- Breakroom
- Fitness Room (Framed Windows)



Date: July 16, 2024

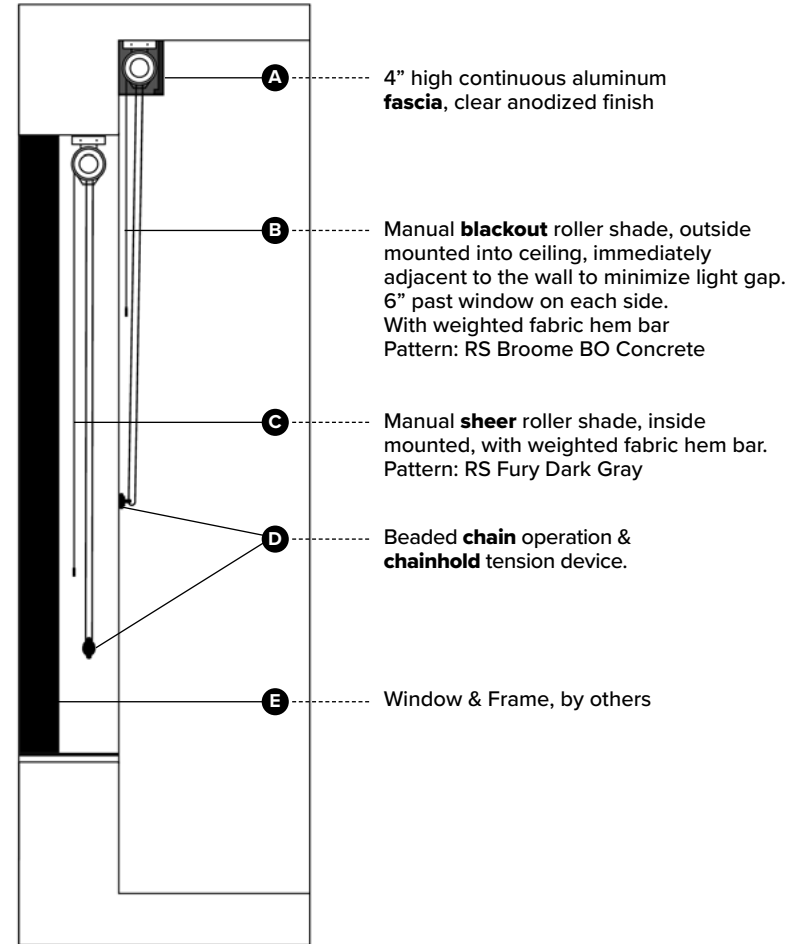

Window Treatment Elevation + Section View

Specification # PA-402

Scale: NTS

Hilton

Public Area Window Treatments
Vibrant Scheme

HOME2
SUITES BY HILTON

PRODUCT DISCLAIMER: Fabtex is a manufacturer of commercial products that require installation by a licensed contractor. All information shown is for schematic purposes and to aid coordination amongst trades. All wiring, connections, means and methods is to be performed by others in strict adherence with all federal, state and local building codes.

CONFIDENTIAL: All materials disclosed in this document are proprietary to Fabtex, Inc. The holder agrees to maintain it in confidence and must not replicate or reveal this information in any manner.

Fabric to meet NFPA 701 FR Standards. Roller Shade Lift System to comply with ANSI WCMA A100.1, Section 2515.03 safety standards.

Spec #PA-402

- Sales Office
- Meeting Room
- Board Room

F A B T E X

Date: July 16, 2024

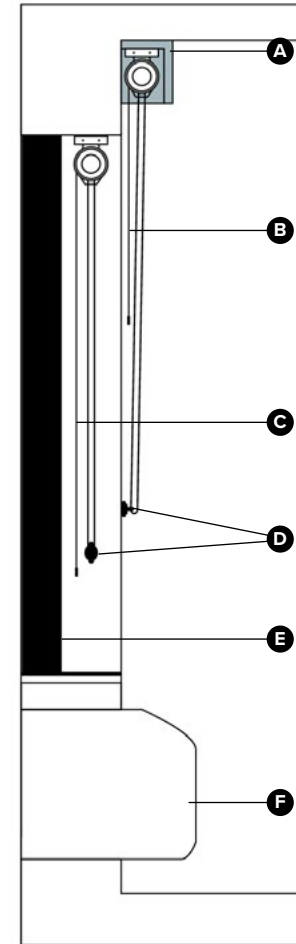
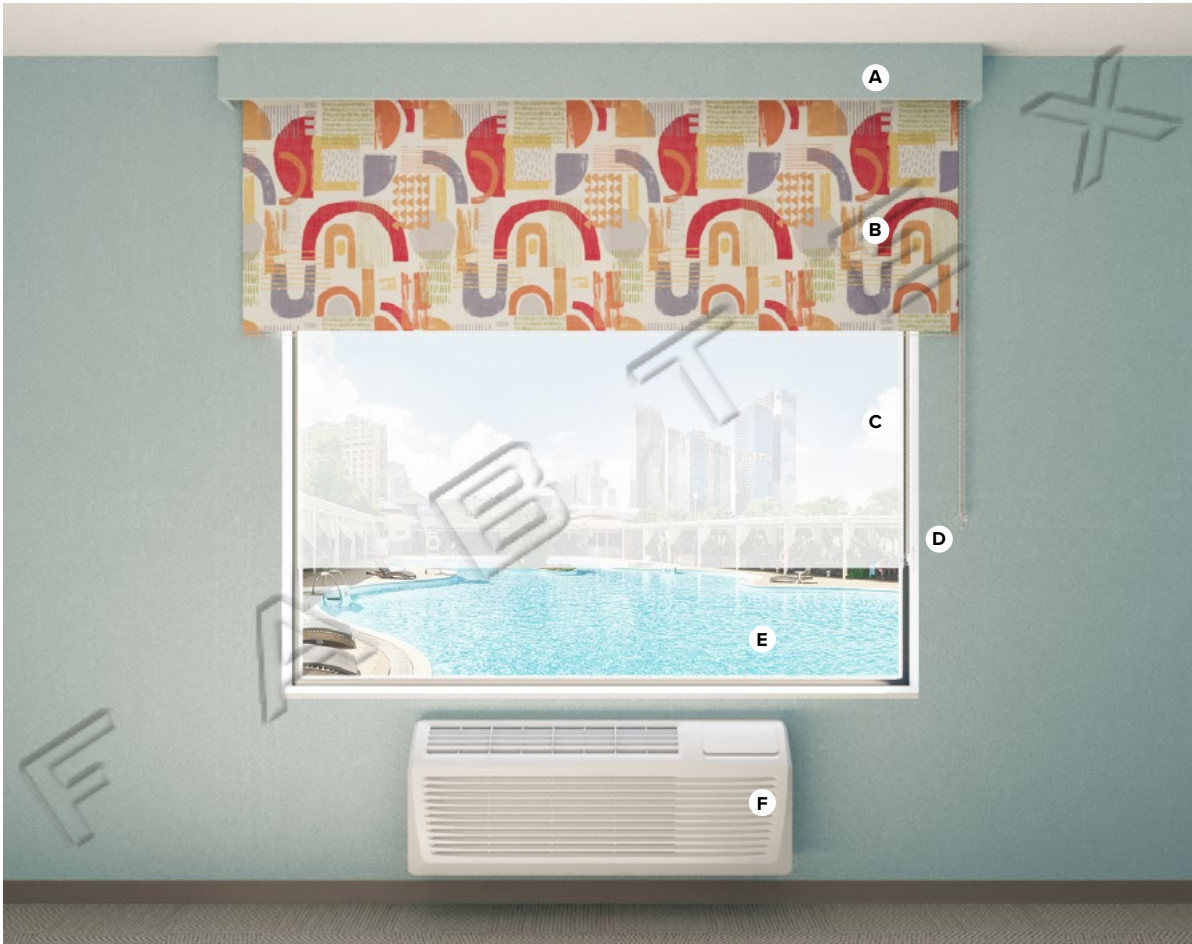

Painted **cornice** (6" High x 3.5" Returns on each side), wall mounted 6" above the window opening, to extend past window 9" on each side. Dustcap to be 3/4" thick. Foam applied between cornice and wall. Color: SW6226 Languid Blue, Eggshell Finish.

Manual **blackout** roller shade, outside mounted into cornice dustcap, to utilize 2" tube to position blackout closer to wall and minimize light bleed. BO fabric to extend 7" past window on each side. With weighted fabric hem bar. Pattern: RS WGR Harlan Custom Multi (Fabric to be RR).

Manual **sheer** roller shade, inside mounted, with weighted fabric hem bar. Pattern: RS Salvador /White

Beaded **chain** operation & **chainhold** tension device.

Window & Frame, by others

PTAC Unit, by others

Window Treatment Elevation + Section View

Specification # (B) GR-400

Scale: NTS

Hilton

Standard Guestroom Window Treatments
New Build - Dynamic Scheme

HOME 2
SUITES BY HILTON

PRODUCT DISCLAIMER: Fabtex is a manufacturer of commercial products that require installation by a licensed contractor. All information shown is for schematic purposes and to aid coordination amongst trades. All wiring, connections, means and methods is to be performed by others in strict adherence with all federal, state and local building codes.

CONFIDENTIAL: All materials disclosed in this document are proprietary to Fabtex, Inc. The holder agrees to maintain it in confidence and must not replicate or reveal this information in any manner.

Fabric to meet NFPA 701 FR Standards. Roller Shade Lift System to comply with ANSI WCMA A100.1, Section 2515.03 safety standards.

F A B T E X

Date: July 16, 2024

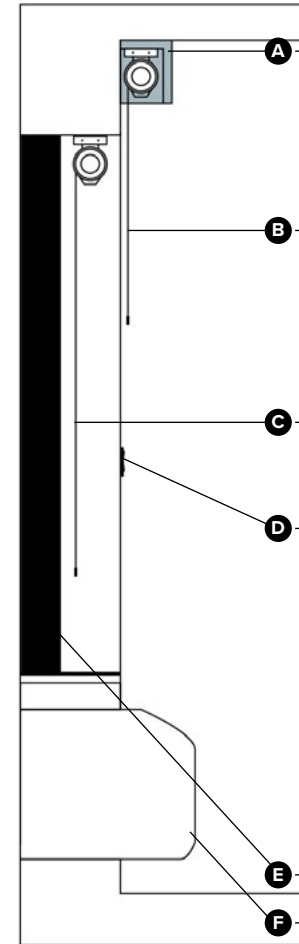

Painted **cornice** (6" High x 3.5" Returns on each side), wall mounted 6" above the window opening, to extend past window 9" on each side. Dustcap to be 3/4" thick. Foam applied between cornice and wall. Color: SW6226 Languid Blue, Eggshell Finish.

Blackout roller shade, outside mounted into cornice dustcap, to utilize 2" tube to position blackout closer to wall and minimize light bleed. BO fabric to extend 7" past window on each side. With weighted fabric hem bar. Pattern: RS WGR Harlan Custom Multi (Fabric to be RR).

Sheer roller shade, inside mounted, with weighted fabric hem bar. Pattern: RS Salvador /White

Levitron rocker **switch**, (HW operation) by GC, or 2 channel wireless wall switch (battery option) by Fabtex

Motorized Option #1 (Preferred) (ML-350PW) hardwired type GC/Owner to provide wiring & switch in accordance with attached diagram.

Motorized Option #2 (Alternate) (ML-350BC) battery operated rechargeable LI batteries via plug-in wall pack.

Window & Frame, by others

PTAC Unit, by others

Window Treatment Elevation + Section View

Specification # (B) GR-401

Scale: NTS

Hilton

ADA Guestroom Window Treatments
New Build - Dynamic Scheme

HOME 2
SUITES BY HILTON

PRODUCT DISCLAIMER: Fabtex is a manufacturer of commercial products that require installation by a licensed contractor. All information shown is for schematic purposes and to aid coordination amongst trades. All wiring, connections, means and methods is to be performed by others in strict adherence with all federal, state and local building codes.

CONFIDENTIAL: All materials disclosed in this document are proprietary to Fabtex, Inc. The holder agrees to maintain it in confidence and must not replicate or reveal this information in any manner.

Fabric to meet NFPA 701 FR Standards. Roller Shade Lift System to comply with ANSI WCMA A100.1, Section 2515.03 safety standards.

Note: All work performed by GC/EC must be in strict accordance with all local building & accessibility codes.

F A B T E X

Date: July 16, 2024

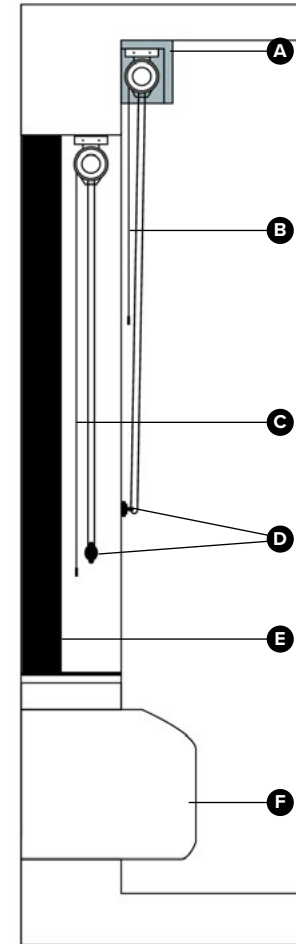
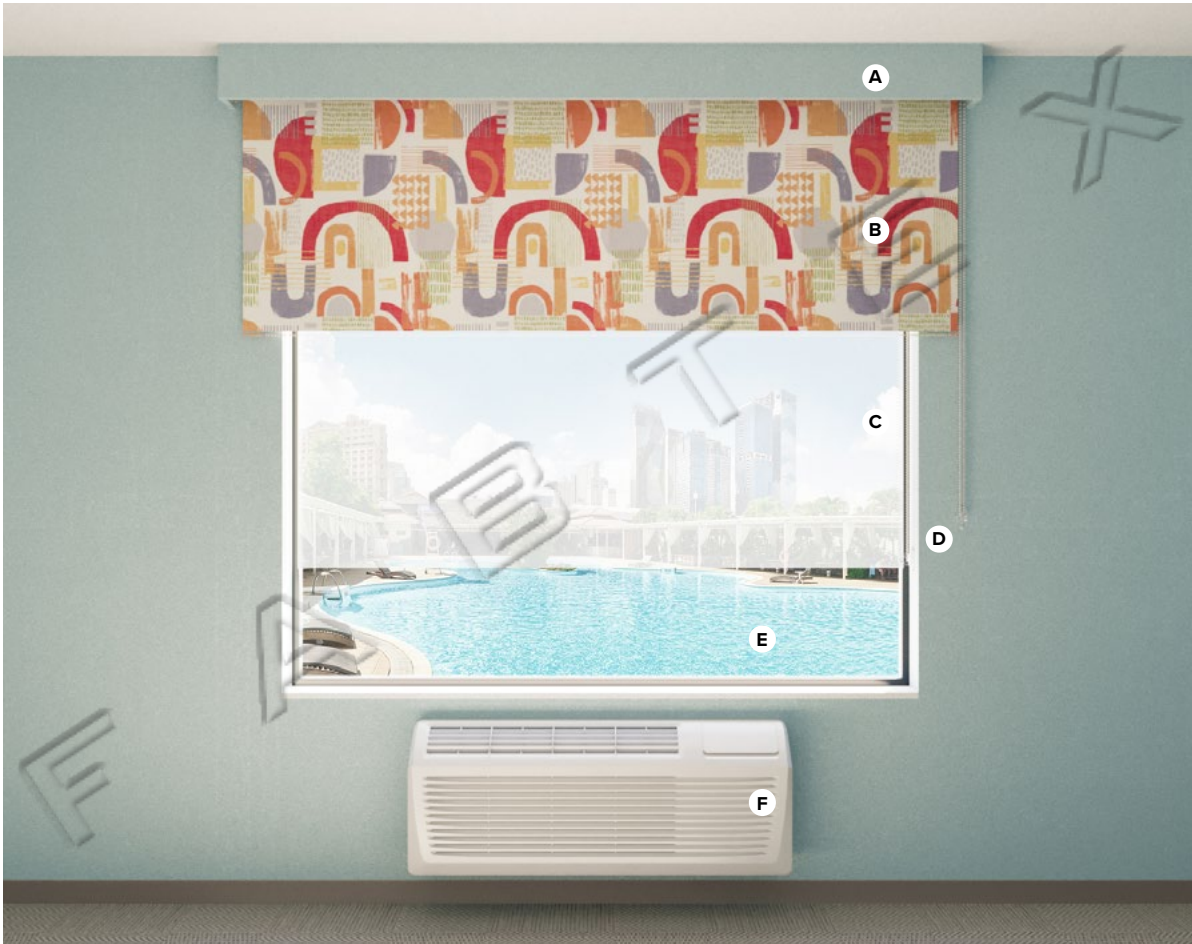

Painted **cornice** (6" High x 3.5" Returns on each side), wall mounted 6" above the window opening, to extend past window 9" on each side. Dustcap to be 3/4" thick. Foam applied between cornice and wall. Color: SW6226 Languid Blue, Eggshell Finish.

Manual **blackout** roller shade, outside mounted into cornice dustcap, to utilize 2" tube to position blackout closer to wall and minimize light bleed. BO fabric to extend 7" past window on each side. With weighted fabric hem bar. Pattern: RS WGR Harlan Custom Multi

Manual **sheer** roller shade, inside mounted, with weighted fabric hem bar. Pattern: RS Salvador /White

Beaded **chain** operation & **chainhold** tension device.

Window & Frame, by others

PTAC Unit, by others

Window Treatment Elevation + Section View

Specification # (B) GR-450

Scale: NTS

Hilton

Standard Guestroom Window Treatments
Renovation - Dynamic Scheme

HOME 2
SUITES BY HILTON

PRODUCT DISCLAIMER: Fabtex is a manufacturer of commercial products that require installation by a licensed contractor. All information shown is for schematic purposes and to aid coordination amongst trades. All wiring, connections, means and methods is to be performed by others in strict adherence with all federal, state and local building codes.

CONFIDENTIAL: All materials disclosed in this document are proprietary to Fabtex, Inc. The holder agrees to maintain it in confidence and must not replicate or reveal this information in any manner.

Fabric to meet NFPA 701 FR Standards. Roller Shade Lift System to comply with ANSI WCMA A100.1, Section 2515.03 safety standards.

F A B T E X

Date: July 16, 2024

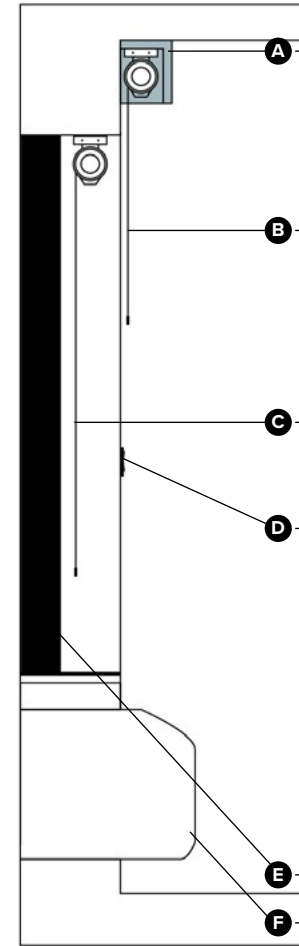
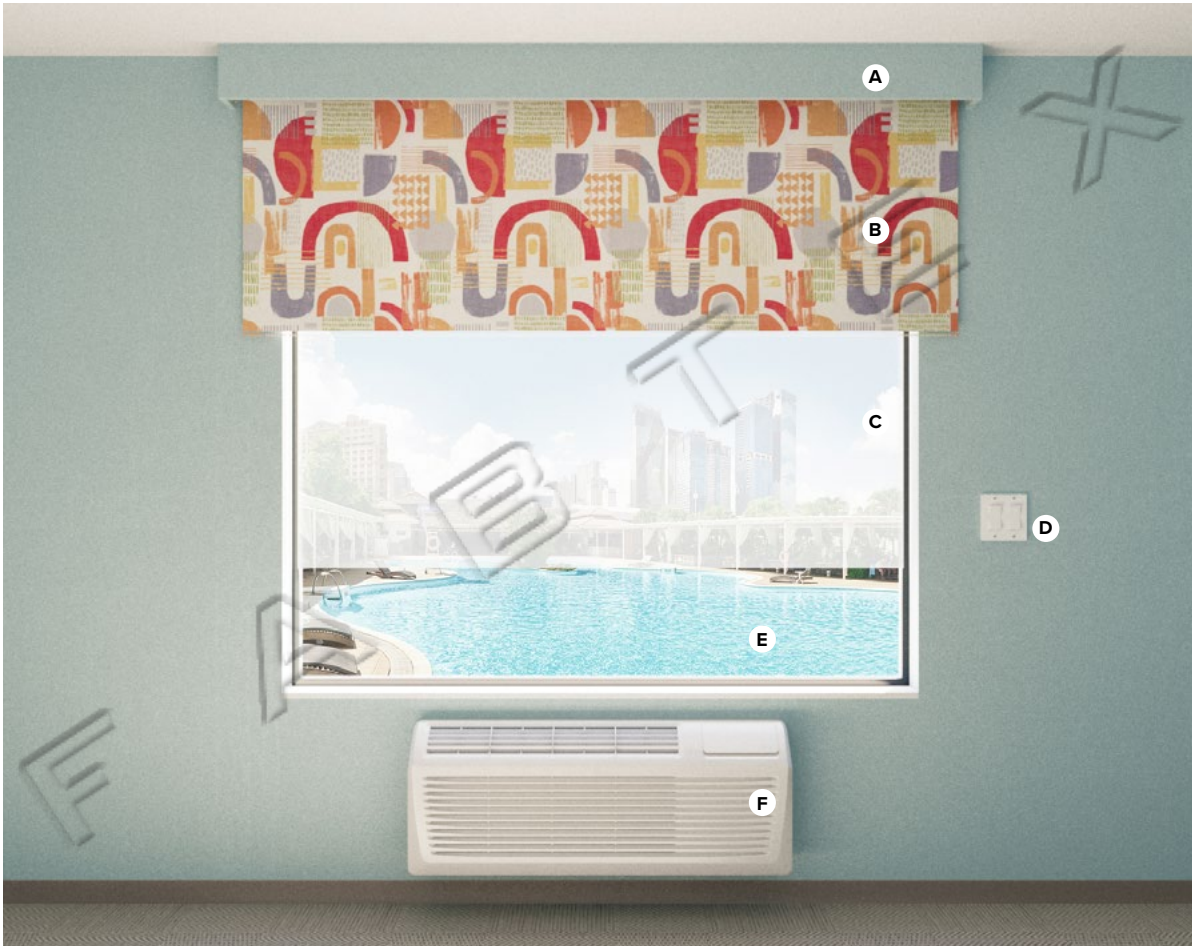

A----- Painted **cornice** (6" High x 3.5" Returns on each side), wall mounted 6" above the window opening, to extend past window 9" on each side. Dustcap to be 3/4" thick. Foam applied between cornice and wall. Color: SW6226 Languid Blue, Eggshell Finish.

B----- **Blackout** roller shade, outside mounted into cornice dustcap, to utilize 2" tube to position blackout closer to wall and minimize light bleed. BO fabric to extend 7" past window on each side. With weighted fabric hem bar. Pattern: RS WGR Harlan Custom Multi

C----- **Sheer** roller shade, inside mounted, with weighted fabric hem bar. Pattern: RS Salvador /White

D----- Levitron rocker **switch**, (HW operation) by GC, or 2 channel wireless wall switch (battery option) by Fabtex

Motorized Option #1 (Preferred) (ML-350PW) hardwired type GC/Owner to provide wiring & switch in accordance with attached diagram.

Motorized Option #2 (Alternate) (ML-350BC) battery operated rechargeable LI batteries via plug-in wall pack.

E----- Window & Frame, by others

F----- PTAC Unit, by others

Window Treatment Elevation + Section View

Specification # (B) GR-451

Scale: NTS

Hilton

ADA Guestroom Window Treatments
Renovation - Dynamic Scheme

HOME 2
SUITES BY HILTON

PRODUCT DISCLAIMER: Fabtex is a manufacturer of commercial products that require installation by a licensed contractor. All information shown is for schematic purposes and to aid coordination amongst trades. All wiring, connections, means and methods is to be performed by others in strict adherence with all federal, state and local building codes.

CONFIDENTIAL: All materials disclosed in this document are proprietary to Fabtex, Inc. The holder agrees to maintain it in confidence and must not replicate or reveal this information in any manner.

Fabric to meet NFPA 701 FR Standards. Roller Shade Lift System to comply with ANSI WCMA A100.1, Section 2515.03 safety standards.

Note: All work performed by GC/EC must be in strict accordance with all local building & accessibility codes.

F A B T E X

Date: July 16, 2024

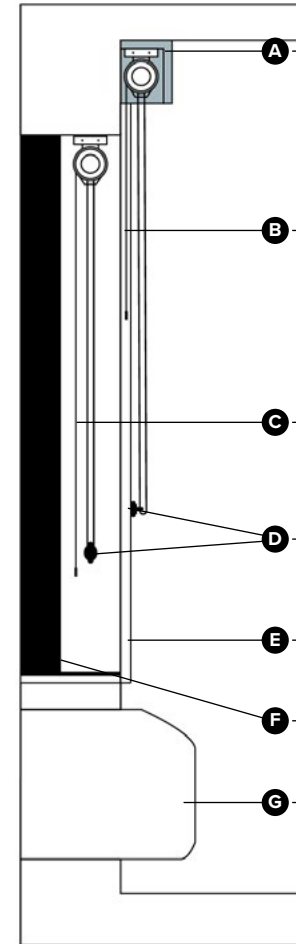

A Painted **cornice** (6" High x 3.5" Returns on each side), wall mounted 6" above the window opening, to extend past window 6" on each side. Dustcap to be 3/4" thick. Foam applied between cornice and wall to minimize light bleed. Color: SW6226 Languid Blue, Eggshell Finish.

B Manual **blackout** roller shade, outside mounted into cornice dustcap, immediately adjacent to the wall to minimize light gap. 2.5" past window on each side. With weighted fabric hem bar Pattern: RS WGR Harlan Custom Multi

C Manual **sheer** roller shade, inside mounted, with weighted fabric hem bar. Pattern: RS Salvador /White

D Beaded **chain** operation & **chainhold** tension device.

E 2 piece **side channels**, white

F Window & Frame, by others

G PTAC Unit, by others

Window Treatment Elevation + Section View

Specification # (B) GR-452

Scale: NTS



**Alternate Guestroom Window Treatments
Renovation - Dynamic Scheme**



PRODUCT DISCLAIMER: Fabtex is a manufacturer of commercial products that require installation by a licensed contractor. All information shown is for schematic purposes and to aid coordination amongst trades. All wiring, connections, means and methods is to be performed by others in strict adherence with all federal, state and local building codes.

CONFIDENTIAL: All materials disclosed in this document are proprietary to Fabtex, Inc. The holder agrees to maintain it in confidence and must not replicate or reveal this information in any manner.

Fabric to meet NFPA 701 FR Standards. Roller Shade Lift System to comply with ANSI WCMA A100.1, Section 2515.03 safety standards.



Date: July 16, 2024

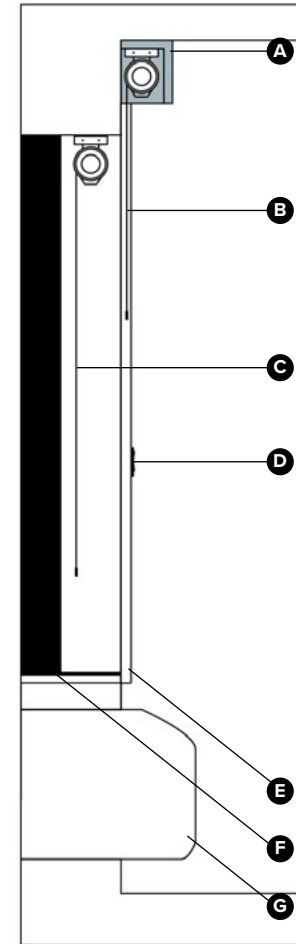

Painted **cornice** (6" High x 3.5" Returns on each side), wall mounted 6" above the window opening, to extend past window 6" on each side. Dustcap to be 3/4" thick. Foam applied between cornice and wall to minimize light bleed. Color: SW6226 Languid Blue, Eggshell Finish.

Blackout roller shade, outside mounted into cornice dustcap, immediately adjacent to the wall to minimize light gap. 2.5" past window on each side. With weighted fabric hem bar Pattern: RS WGR Harlan Custom Multi

Sheer roller shade, inside mounted, with weighted fabric hem bar. Pattern: RS Salvador /White

Levitron rocker **switch**, (HW operation) by GC, or 2 channel wireless wall switch (battery option) by Fabtex

Motorized Option #1 (Preferred) (ML-350PW) hardwired type GC/Owner to provide wiring & switch in accordance with attached diagram.

Motorized Option #2 (Alternate) (ML-350BC) battery operated rechargeable LI batteries via plug-in wall pack.

E----- 2 piece **side channels**, white

F----- Window & Frame, by others

G----- PTAC Unit, by others

Window Treatment Elevation + Section View

Specification # (B) GR-453

Scale: NTS

Hilton

ADA Alternate Guestroom Window Treatments Renovation - Dynamic Scheme

HOME 2
SUITES BY HILTON

PRODUCT DISCLAIMER: Fabtex is a manufacturer of commercial products that require installation by a licensed contractor. All information shown is for schematic purposes and to aid coordination amongst trades. All wiring, connections, means and methods is to be performed by others in strict adherence with all federal, state and local building codes.

CONFIDENTIAL: All materials disclosed in this document are proprietary to Fabtex, Inc. The holder agrees to maintain it in confidence and must not replicate or reveal this information in any manner.

Fabric to meet NFPA 701 FR Standards. Roller Shade Lift System to comply with ANSI WCMA A100.1, Section 2515.03 safety standards.

Note: All work performed by GC/EC must be in strict accordance with all local building & accessibility codes.

F A B T E X

Date: July 16, 2024

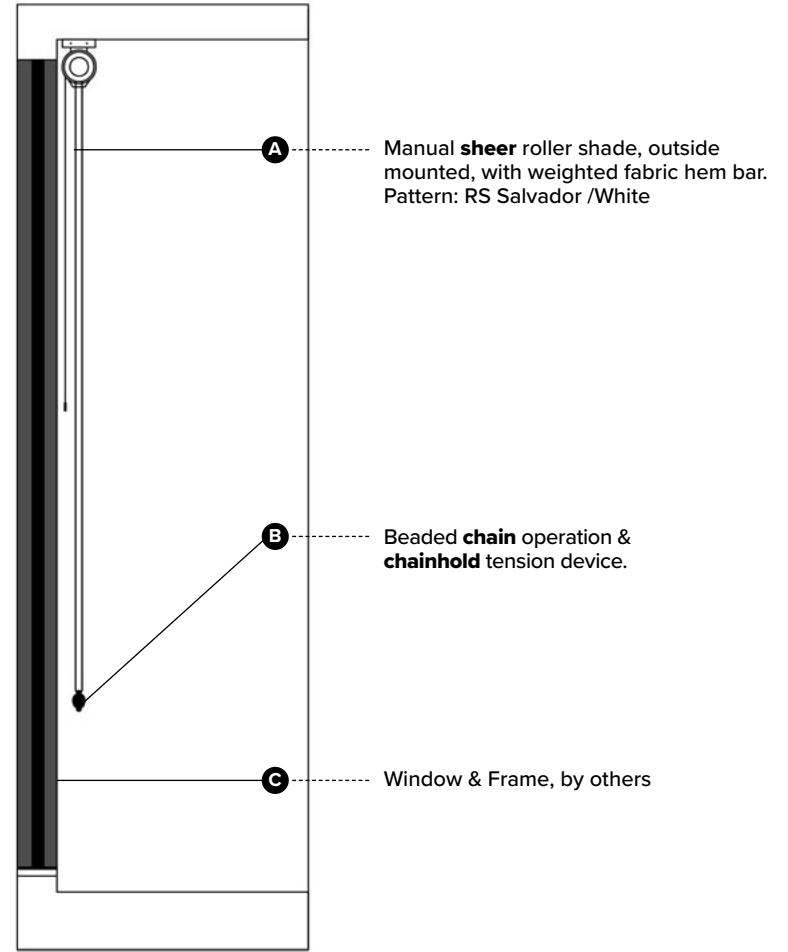

Window Treatment Elevation + Section View

Specification # PA-400

Scale: NTS

Hilton

Public Area Window Treatments
Dynamic Scheme

HOME²
SUITES BY HILTON

PRODUCT DISCLAIMER: Fabtex is a manufacturer of commercial products that require installation by a licensed contractor. All information shown is for schematic purposes and to aid coordination amongst trades. All wiring, connections, means and methods is to be performed by others in strict adherence with all federal, state and local building codes.

CONFIDENTIAL: All materials disclosed in this document are proprietary to Fabtex, Inc. The holder agrees to maintain it in confidence and must not replicate or reveal this information in any manner.

Fabric to meet NFPA 701 FR Standards. Roller Shade Lift System to comply with ANSI WCMA A100.1, Section 2515.03 safety standards.

Spec #PA-400

- Lobby
- Fitness Room

F A B T E X

Date: July 16, 2024

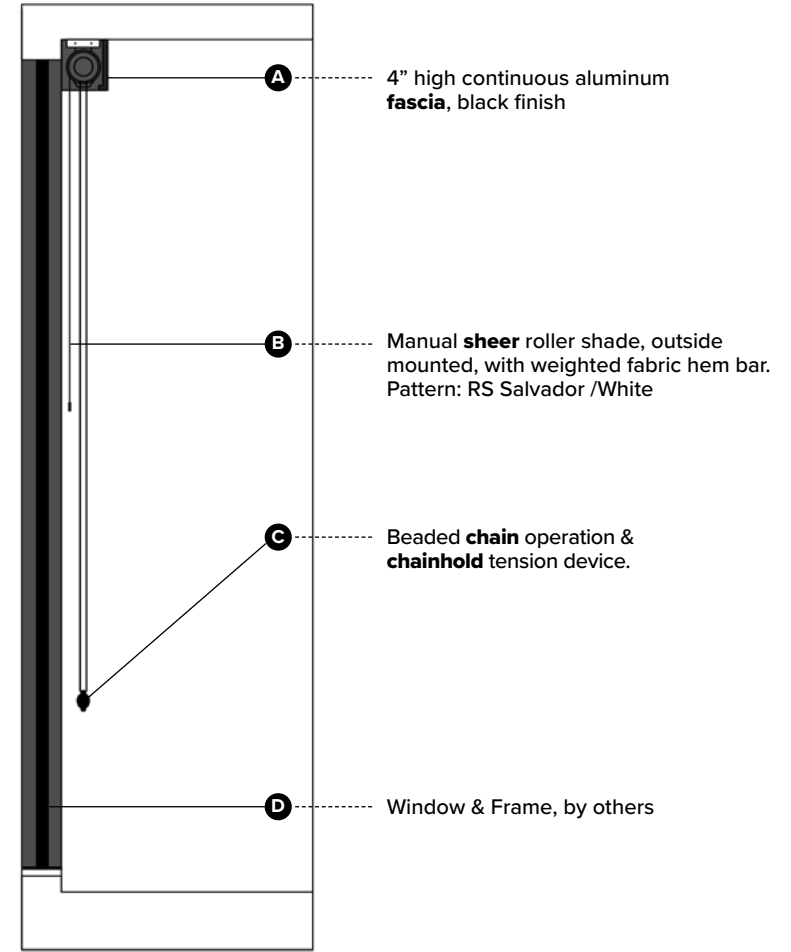
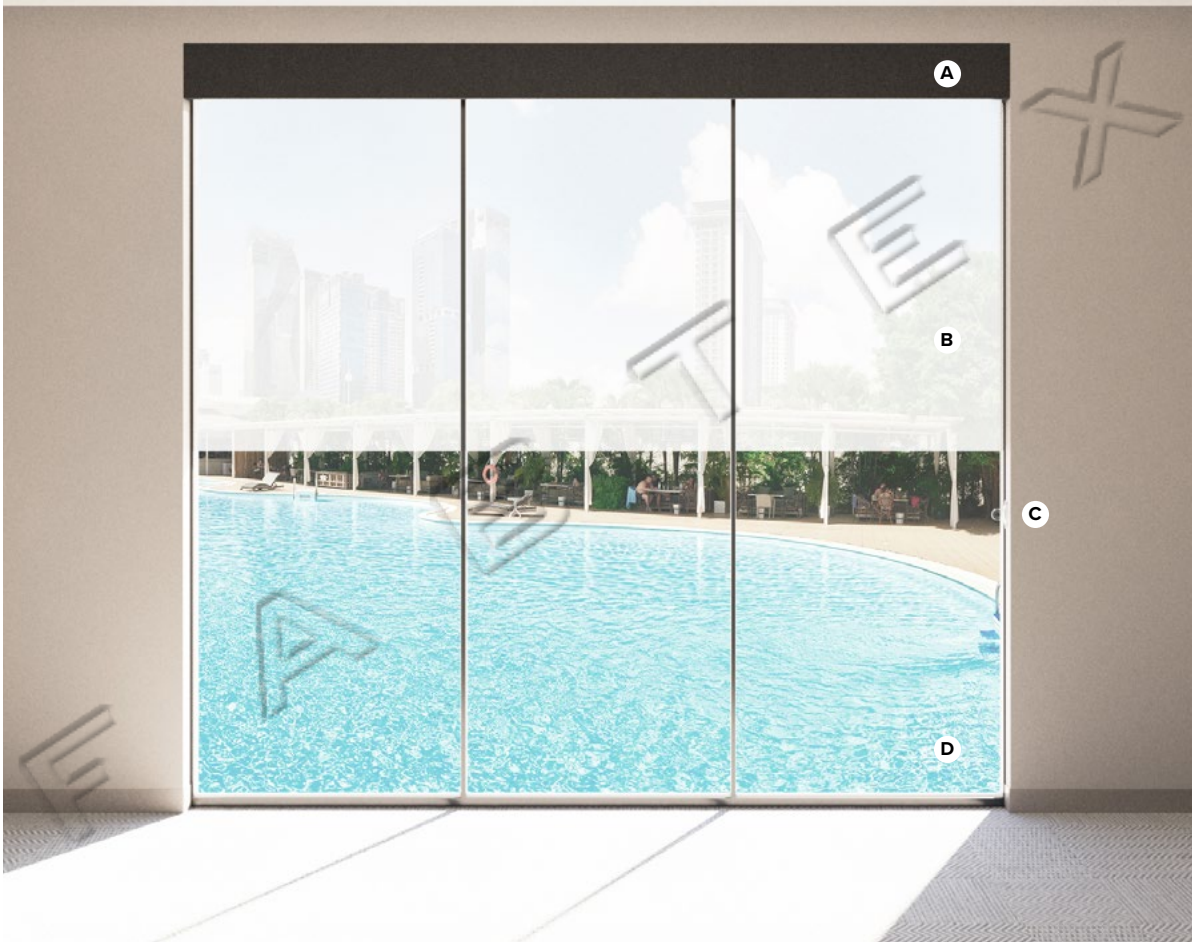

Window Treatment Elevation + Section View

Specification # PA-401

Scale: NTS

Hilton

Public Area Window Treatments
Dynamic Scheme

HOME2
SUITES BY HILTON

PRODUCT DISCLAIMER: Fabtex is a manufacturer of commercial products that require installation by a licensed contractor. All information shown is for schematic purposes and to aid coordination amongst trades. All wiring, connections, means and methods is to be performed by others in strict adherence with all federal, state and local building codes.

CONFIDENTIAL: All materials disclosed in this document are proprietary to Fabtex, Inc. The holder agrees to maintain it in confidence and must not replicate or reveal this information in any manner.

Fabric to meet NFPA 701 FR Standards. Roller Shade Lift System to comply with ANSI WCMA A100.1, Section 2515.03 safety standards.

Spec #PA-401

- Breakroom
- Fitness Room (Framed Windows)

F A B T E X

Date: July 16, 2024

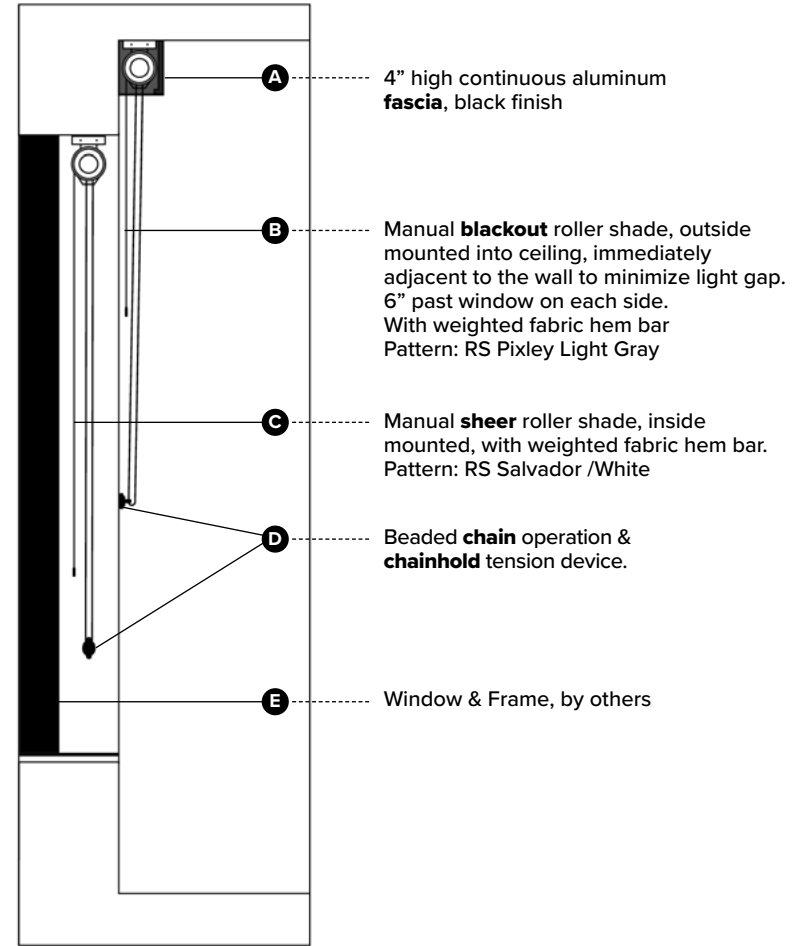
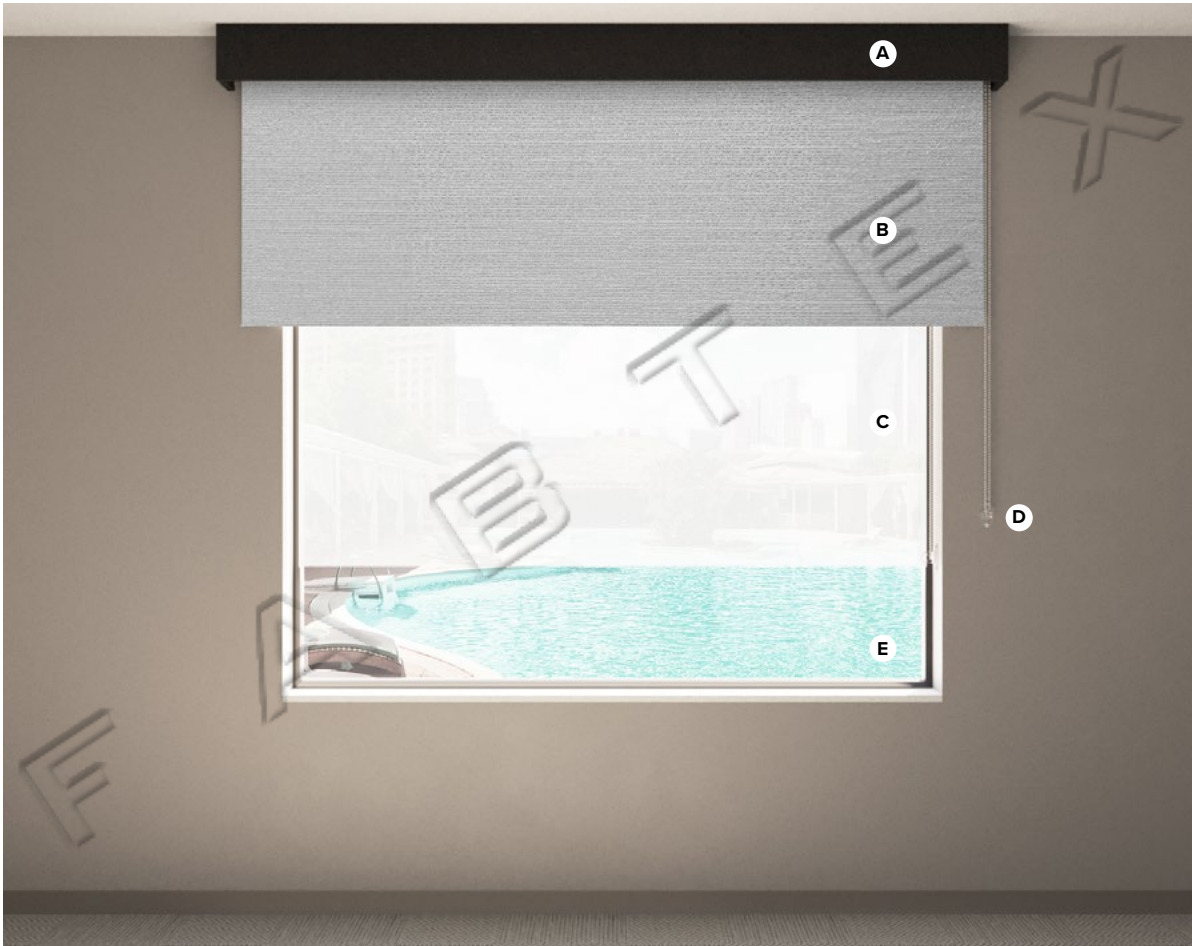

Window Treatment Elevation + Section View

Specification # PA-402

Scale: NTS

Hilton

Public Area Window Treatments
Dynamic Scheme

HOME2
SUITES BY HILTON

PRODUCT DISCLAIMER: Fabtex is a manufacturer of commercial products that require installation by a licensed contractor. All information shown is for schematic purposes and to aid coordination amongst trades. All wiring, connections, means and methods is to be performed by others in strict adherence with all federal, state and local building codes.

CONFIDENTIAL: All materials disclosed in this document are proprietary to Fabtex, Inc. The holder agrees to maintain it in confidence and must not replicate or reveal this information in any manner.

Fabric to meet NFPA 701 FR Standards. Roller Shade Lift System to comply with ANSI WCMA A100.1, Section 2515.03 safety standards.

Spec #PA-402

- Sales Office
- Meeting Room
- Board Room

F A B T E X

Date: July 16, 2024

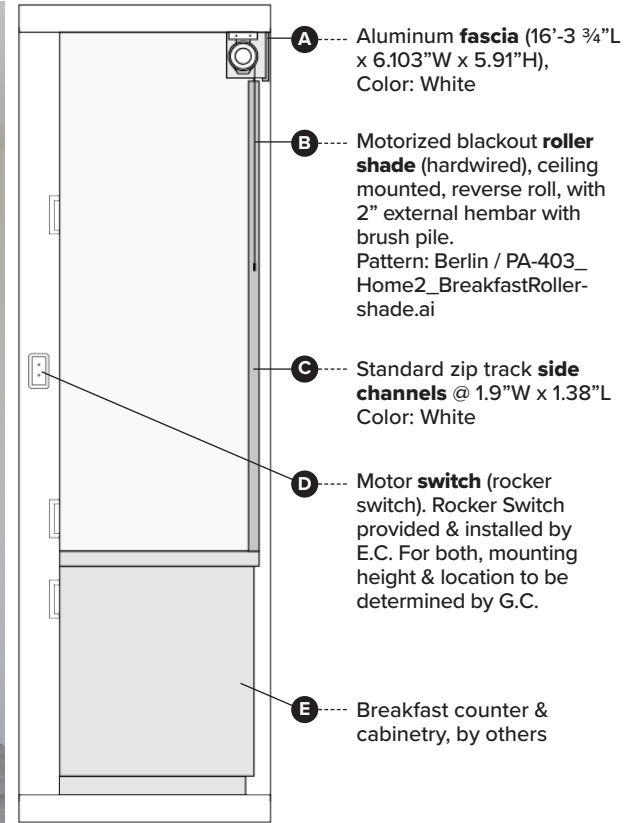

Elevation + Left Section View

Scale: NTS

Hilton

Public Area - Breakfast Shade Treatments
PA-403

HOME2
SUITES BY HILTON

Fabric to meet NFPA 701 FR,
ASTM G21 & ASTM E2180
Standards.



PRODUCT DISCLAIMER: Fabtex is a manufacturer of commercial products that require installation by a licensed contractor. All information shown is for schematic purposes and to aid coordination amongst trades. All wiring, connections, means and methods is to be performed by others in strict adherence with all federal, state and local building codes.

CONFIDENTIAL: All materials disclosed in this document are proprietary to Fabtex, Inc. The holder agrees to maintain it in confidence and must not replicate or reveal this information in any manner.

Date: July 16, 2024



Showing roller shades fully opened



Angled view

Shade Detail - Section

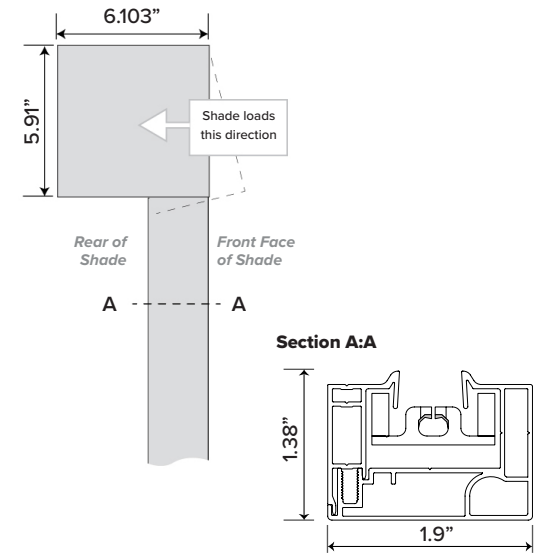

Shade Detail - Elevation

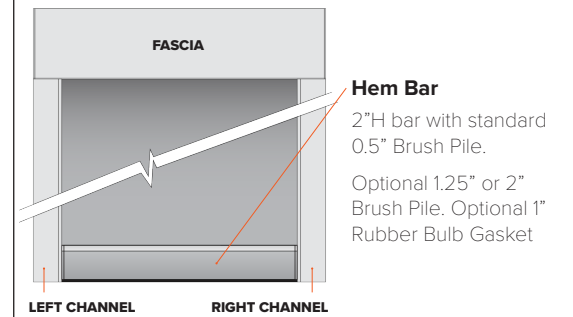

Public Area - Breakfast Shade Treatments
PA-403



Fabric to meet NFPA 701 FR,
ASTM G21 & ASTM E2180
Standards.



PRODUCT DISCLAIMER: Fabtex is a manufacturer of commercial products that require installation by a licensed contractor. All information shown is for schematic purposes and to aid coordination amongst trades. All wiring, connections, means and methods is to be performed by others in strict adherence with all federal, state and local building codes.

CONFIDENTIAL: All materials disclosed in this document are proprietary to Fabtex, Inc. The holder agrees to maintain it in confidence and must not replicate or reveal this information in any manner.

Date: July 16, 2024

Motor

110V Hardwired Motor w/ 110V Rocker Switch

Wiring layout:

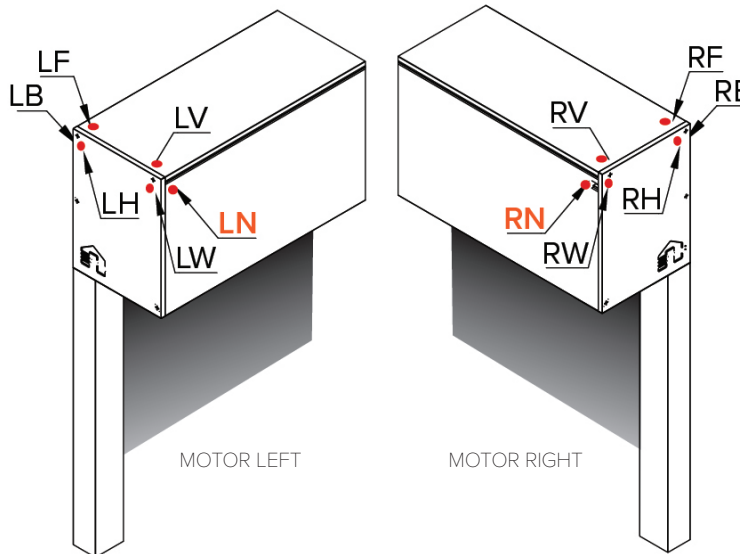
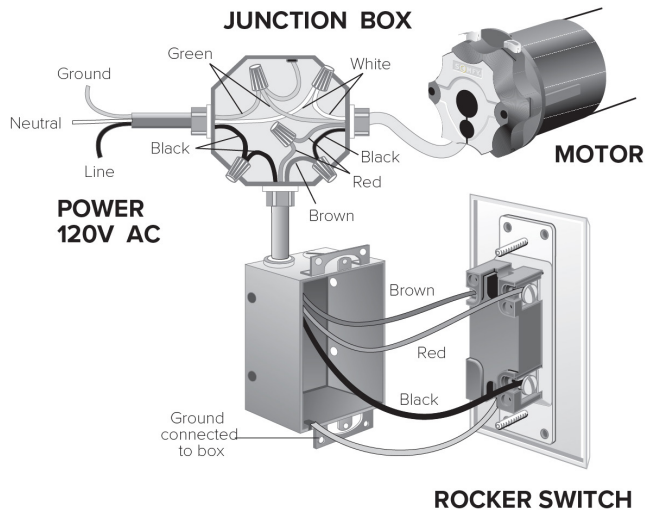

Cable Exit Options

The motor can be located on the left or right of the shade box. The motor's power cord can exit at 6 different points through a rubber weather proof grommet. Please specify which exit location you prefer. **LN & RN are preferred.**

The cable can also exit down from the head box and integrated into the side channel.

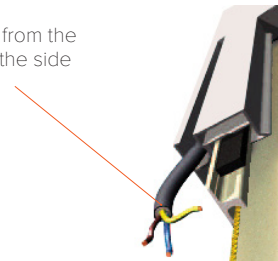

Switch

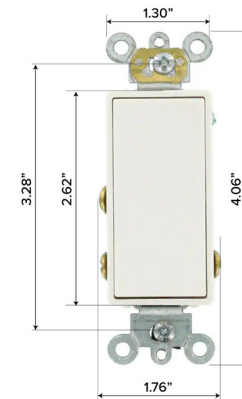

RECOMMENDED - SUPPLIED BY E.C.

Leviton 5657-2W, White Momentary Contact **Rocker Switch** (hardwired)

- 15 Amp, 120/277 Volt
- Decora Plus Rocker double-throw Ctr-OFF momentary contact single-pole AC quiet switch
- Self grounding
- Back & side wired

Hilton

Public Area - Breakfast Shade Treatments
PA-403

HOME2
SUITES BY HILTON

PRODUCT DISCLAIMER: Fabtex is a manufacturer of commercial products that require installation by a licensed contractor. All information shown is for schematic purposes and to aid coordination amongst trades. All wiring, connections, means and methods is to be performed by others in strict adherence with all federal, state and local building codes.

CONFIDENTIAL: All materials disclosed in this document are proprietary to Fabtex, Inc. The holder agrees to maintain it in confidence and must not replicate or reveal this information in any manner.

F A B T E X

Date: July 16, 2024

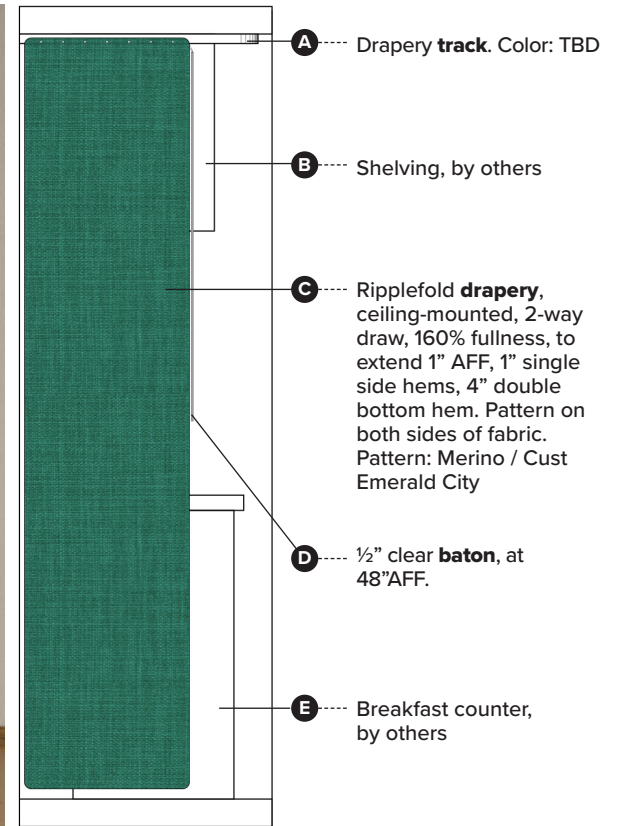



Window Treatment Elevation + Left Section View

Elevation shows drapes partially open. Section shows drapes in closed/stacked position.

Specification # (A) PA-450

Scale: NTS

 <p>Public Area - Breakfast Window Treatments Vibrant Scheme - Reno Only</p> 	<p>Fabric to meet Class 1 ASTM E-84 & NFPA 701 FR Standards.</p>	
<p>PRODUCT DISCLAIMER: Fabtex is a manufacturer of commercial products that require installation by a licensed contractor. All information shown is for schematic purposes and to aid coordination amongst trades. All wiring, connections, means and methods is to be performed by others in strict adherence with all federal, state and local building codes.</p> <hr style="border-top: 1px dashed #000;"/> <p>CONFIDENTIAL: All materials disclosed in this document are proprietary to Fabtex, Inc. The holder agrees to maintain it in confidence and must not replicate or reveal this information in any manner.</p>		<p>Date: July 16, 2024</p>

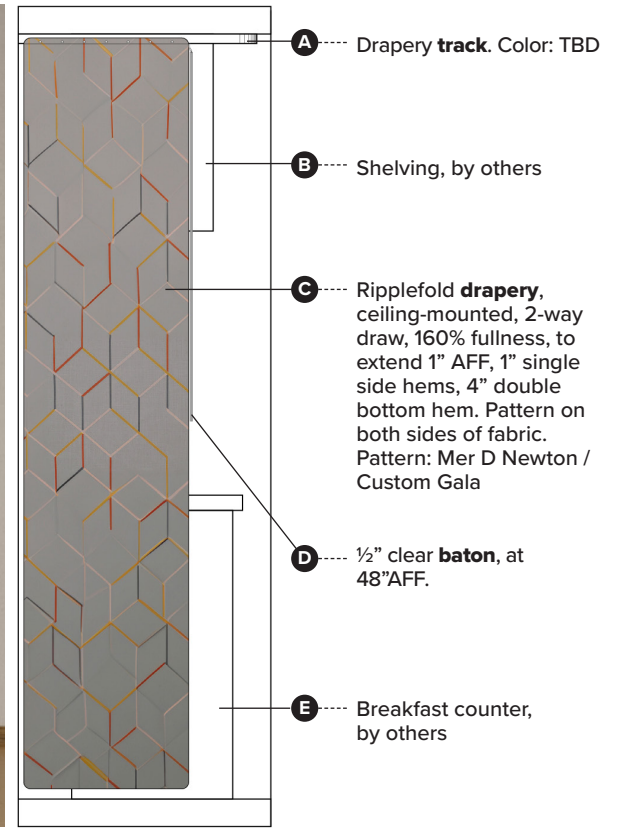

Window Treatment Elevation + Left Section View

Elevation shows drapes partially open. Section shows drapes in closed/stacked position.

Specification # (B) PA-450

Scale: NTS

Hilton

Public Area - Breakfast Window Treatments
Dynamic Scheme - Reno Only

HOME 2
SUITES BY HILTON

Fabric to meet Class 1 ASTM
E-84 & NFPA 701 FR Standards.

F A B T E X

PRODUCT DISCLAIMER: Fabtex is a manufacturer of commercial products that require installation by a licensed contractor. All information shown is for schematic purposes and to aid coordination amongst trades. All wiring, connections, means and methods is to be performed by others in strict adherence with all federal, state and local building codes.

CONFIDENTIAL: All materials disclosed in this document are proprietary to Fabtex, Inc. The holder agrees to maintain it in confidence and must not replicate or reveal this information in any manner.

Date: July 16, 2024